

LED STATUS

Led Status	Internal controller with 4 driving modes	
1	100%	Continuous use
2	200%	Semi-continuous use
3	400%	Strobe use
4	10-100%	Analog Reg

Internal Controller with
4 driving modes



M12 5P Male Connector	
Pin 1	+24V
Pin 2	Start NPN < 1 to 0V
Pin 3	GND
Pin 4	Start PNP > 3 to 24V
Pin 5	1-10V Analog Reg.

develop your custom solution

18 Standard Colours

Base IP54 Protection Degree

Variant IP65 Protection Degree

24 Vdc

Optional Polarizing Filter

CE RoHS

UK CA

Illuminator Features :

- Project achieved by internal resources and Genesi skills;
- Fast controller which allows to have the following modes: continuous use, semi-continuous use, strobe (PNP, NPN), analog regulation.
- Microcontroller to monitor the pulse duration and the maximum temperature;
- Model with 10°, 30°, 60° Lenses or transparent, satin and opaline covers;
- Powerful and Fast strobe mode with energy buffering and strobe duration control, min. pulse from 3 µs;

COLOUR	WHITE		UV-A				VISIBLE				NIR			SWIR				
	White 6000K	White 4000K	UV 365nm	UV 385nm	UV 395nm	UV 405nm	Blue 450nm	Green 524nm	Red 625nm	Deep Red 660nm	IR 730nm	IR 850nm	IR 950nm	SWIR 1050nm	SWIR 1200nm	SWIR 1300nm	SWIR 1450nm	SWIR 1550nm
Led Colour	-6K	-4K	-365	-385	-395	-405	-450	-524	-625	-660	-730	-850	-950	-1050	-1200	-1300	-1450	-1550
Continuous use power	100 %		175 %				200 %				200 %			200 %				
Semi-continuous use power	200 %		175 %				200 %				200 %			180 %				
Strobe use power	400 %		330 %				400 %				400 %			400 %				



Genesi LUX

GENESI ELETTRONICA SRL - VIA BACHELET, 3/A - 41057 SPILAMBERTO (MO) - ITALY

info@genesi-lux.it - TEL. +39 059785566 - www.genesi-elettronica.com

©All Rights Reserved GENESI ELETTRONICA - GS - GENESI SPOT



Organization with a certified ISO 9001:2015 Quality Management System

Rev. 01/24

GS Part Number

Ex. Code : **GSXXX** -**YYY** -**WW1** -**WW2**

XXX	Base Lengths
GSX1	5 cm
GSQ1	5 cm
GSQ2	9 cm
GSQ3	12 cm
GSXXX	from 5 cm to 50 cm on demand

-YYY	Led Colours		EN 62471
-6K	Base 6000K Cold White	White	-L10 RISK1
-4K	4000K Natural White		RISK2
-365	UV 365 nm	UV - A	RISK3
-385	UV 385 nm		
-395	UV 395 nm		
-405	UV 405 nm		
-450	450 nm Royal Blue	Visible	RISK2
-524	524 nm Green		RISK1
-625	625 nm Red		
-660	660 nm Deep Red		
-730	730 nm IR	Nir	RISK2
-850	850 nm IR		
-950	950 nm IR		
-1050	1050 nm SWIR	Swir	RISK2
-1200	1200 nm SWIR		
-1300	1300 nm SWIR		
-1450	1450 nm SWIR		
-1550	1550 nm SWIR		
-YYY	Colour on demand		

-WW1	Cover variants
-T	Base Trasparent cover
-OP	Base Opaline cover
-ST	Satin cover
-T65	Transparent cover IP65
-L10	10° lens + trasparent cover
-L30	30° lens + trasparent cover
-L60	60° lens + trasparent cover
-P	Polarizing filter cover
-WW1	Cover on demand

-WW2	Cables
	20cm cable + M12 5P M
-WW2	Cable on demand

Not all combinations are available

Part Number Examples:

GSX1-6K-L10
Spot 4 Driving Modes 50x50mm White 6000K 10° Lens + transparent cover 600/2250Lm 0,2/0,65A 4/15W 20 cm cable M12 M 5P

GSX1-1450-L10
Spot 4 Driving Modes 50x50mm SWIR 1450nm 10° Lens + transparent cover 0,1/0,3A 2/6W 20 cm cable M12 M 5P

GSQ1-524-L30
Spot 4 core 4 Driving Modes 50x50mm Green 524nm 30° Lens + transparent cover 0,4/2A 8/50W 20 cm cable M12 M 5P



GENESI ELETTRONICA SRL - VIA BACHELET, 3/A - 41057 SPILAMBERTO (MO) - ITALY
info@genesi-lux.it - TEL. +39 059785566 - www.genesi-elettronica.com
 ©All Rights Reserved GENESI ELETTRONICA - GS - GENESI SPOT



Organization with a certified ISO 9001:2015 Quality Management System

Rev. 01/24

OPERATING MODE

100% CONTINUOUS USE

Connector	PINS	Function	Description
	1	+24 V	A) START NPN → PIN2: 0 to 1 V; B) START PNP → PIN4: 3 to 24 V; For the continuous use: it is possible to connect PIN4 directly to +24 V or PIN2 to GND
	2	A) Start NPN: 0-1 V	
	3	GND	
	4	B) Start PNP: 3-24 V	
	5	-	

200% SEMI-CONTINUOUS USE

Connector	PINS	Function	Description
	1	+24 V	Precondition: PIN5: 24 V A) START NPN → PIN2: 0 to 1 V; B) START PNP → PIN4: 3 to 24 V; In this mode → Ton_{max} = 60 s - Dt_{max} = 50% For the semi-continuous use: it is possible to connect PIN4 directly to +24 V or PIN2 to GND. To use it in continuous mode with DT _{max} from 51% to 100%: it is necessary to use the heat sink or forced ventilation.
	2	A) Start NPN: 0-1 V	
	3	GND	
	4	B) Start PNP: 3-24 V	
	5	+24 V	

400% STROBE USE



Connector	PINS	Function	Description
	1	+24 V	A) START NPN → PIN2: 0 to 1 V; B) START PNP → PIN4: 3 to 24 V; In this mode → Ton_{max} = 10 ms - Dt_{max} = 10% AUTO-SWITCH in continuous use.
	2	A) Start NPN: 0-1 V	
	3	GND	
	4	B) Start PNP: 3-24 V	
	5	-	

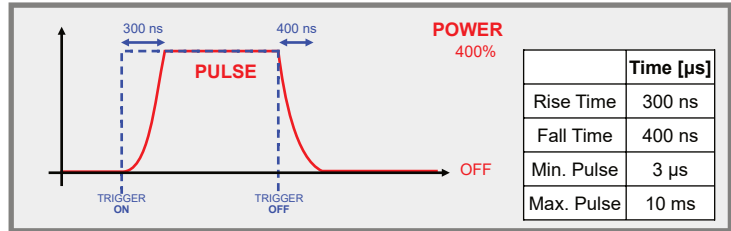
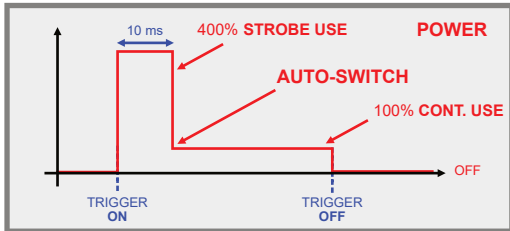

ANALOG REGULATION USE 100%

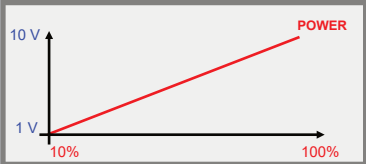
Connector	PINS	Function	Description
	1	+24 V	PIN5 from 1 to 10 V can adjust the power from 10% to 100%. 
	2	-	
	3	GND	
	4	-	
	5	1 V - 10 V	



400% STROBE USE POWER can be reached only from WHITE / VISIBLE / NIR LEDS, for other wavelengths check the power table at page 1.



MicroController temperature protection → at 80°C the PCB enables the protection and restores the functioning at T < 60°C.

MECHANICAL DRAWING

Scale	Unit of measurement
1:1	mm
Weight	
180 g	

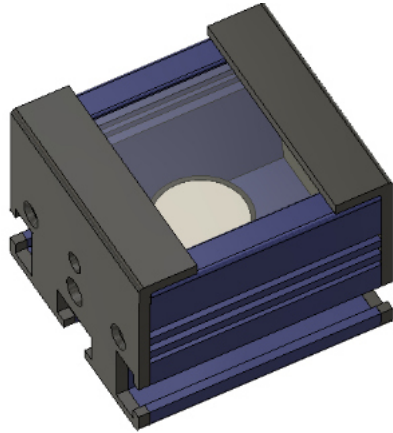
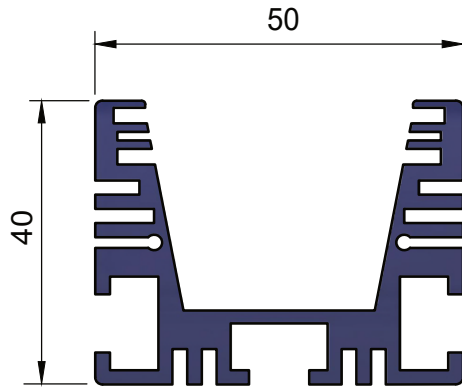

GSX1

GSQ1

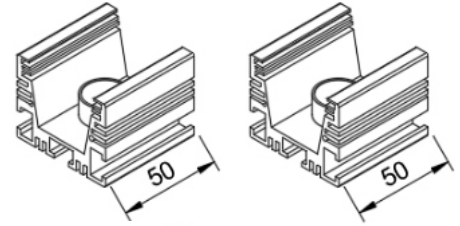

GSQ2

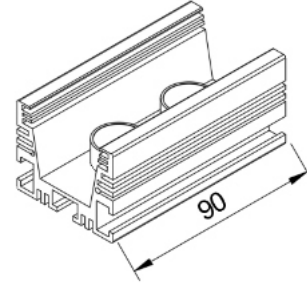

GSQ3

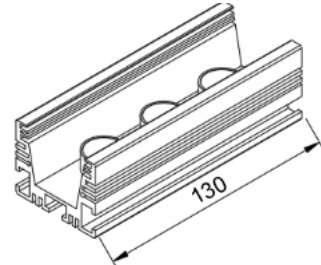

For 3D mechanical drawing requests - info@genesi-lux.it

LIGHT PROJECTION

GSX1-6K-L10°		
Working distance	Diameter mm	Power W/m ² Cont./S.cont/Strobe
20 cm	50	245-428-856
40 cm	70	93-161-322
100 cm	240	14-23.4-46.8

GSX1-6K-L30°		
Working distance	Diameter mm	Power W/m ² Cont./S.cont/Strobe
20 cm	80	126-222-444
40 cm	150	30-52-104
100 cm	400	5-9-18

GSX1-6K-L60°		
Working distance	Diameter mm	Power W/m ² Cont./S.cont/Strobe
20 cm	200	24-43-86
40 cm	380	7-12-24
100 cm	980	1.3-2.2-4.4

GSX1-6K-T		
Working distance	Diameter mm	Power W/m ² Cont./S.cont/Strobe
20 cm	310	5.8-10.5-21
40 cm	320	2.3-4.1-8.2
100 cm	1380	0.39-0.66-1.32

GSX1-6K-ST		
Working distance	Diameter mm	Power W/m ² Cont./S.cont/Strobe
20 cm	240	4.7-8.84-17.7
40 cm	420	1.8-3.1-6.2
100 cm	1080	0.32-0.53-1

GSX1-6K-OP		
Working distance	Diameter mm	Power W/m ² Cont./S.cont/Strobe
20 cm	280	1.7-3-6
40 cm	520	0.65-1.1-2.2
100 cm	1500	0.14-0.21-0.48



GSQ1-6K-L30°		
Working distance	Diameter mm	Power W/m ² Cont./S.cont/Strobe
20 cm	100	114-180-360
40 cm	200	41.5-64.5-129
100 cm	440	6.2-9.3-18.6

GSQ1-6K-L60°		
Working distance	Diameter mm	Power W/m ² Cont./S.cont/Strobe
20 cm	220	45-73-146
40 cm	400	13.5-21.5-43
100 cm	850	2.5-4-8

GSQ1-6K-T		
Working distance	Diameter mm	Power W/m ² Cont./S.cont/Strobe
20 cm	300	11-18-36
40 cm	520	3.6-5.6-11.2
100 cm	1140	0.69-1-2

GSQ1-6K-ST		
Working distance	Diameter mm	Power W/m ² Cont./S.cont/Strobe
20 cm	240	9-14.2-28.4
40 cm	380	3.5-5.4-10.8
100 cm	1100	0.57-0.86-1.72

GSQ1-6K-OP		
Working distance	Diameter mm	Power W/m ² Cont./S.cont/Strobe
20 cm	280	3.3-5.2-10.4
40 cm	480	1.2-1.8-3.6
100 cm	1640	0.22-0.31-0.62

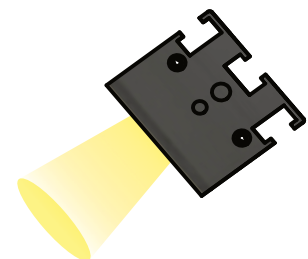

Design & Production
Made in Italy



Genesi LUX

GENESI ELETTRONICA SRL - VIA BACHELET, 3/A - 41057 SPILAMBERTO (MO) - ITALY

info@genesi-lux.it - TEL. +39 059785566 - www.genesi-elettronica.com

©All Rights Reserved GENESI ELETTRONICA - GS - GENESI SPOT



Organization with a certified ISO 9001:2015 Quality Management System

Rev. 01/24

ACCESSORIES

CODE	DESCRIPTION
GS-FIX-R	Rotating GS fixing
GS-R1	Auxiliary heat radiator for GSX1 & GSQ1 (to work 100% semi-continuous mode)
GS-R2	Auxiliary heat radiator for GSQ2 (to work 100% semi-continuous mode)
GS-R3	Auxiliary heat radiator for GSQ3 (to work 100% semi-continuous mode)
GE-M12F-5X050-2M	M12 connector 2 meter long female cable
GE-M12F-5X050-5M	M12 connector 5 meter long female cable
GE-M12F-5X050-10M	M12 connector 10 meter long female cable
GE-ABS606E	LED Voltage Controller with 6 programmable channels and 10/100 Ethernet. Second level controller for Camera and illuminator.

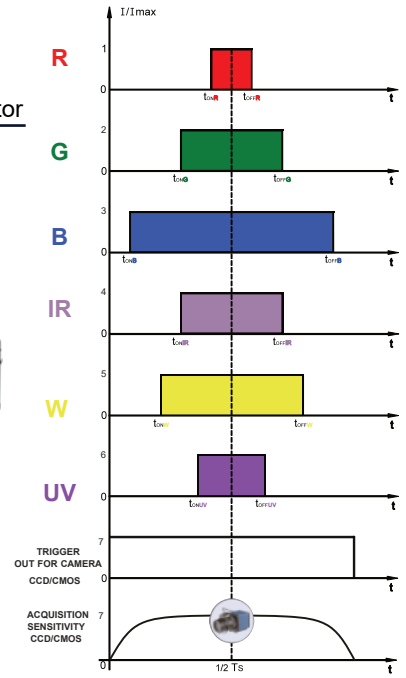
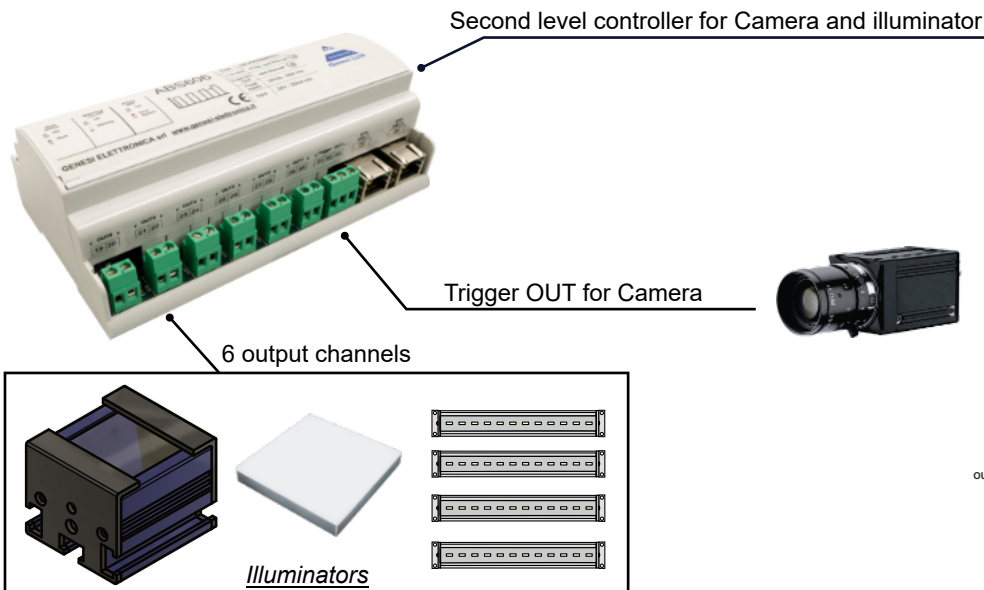
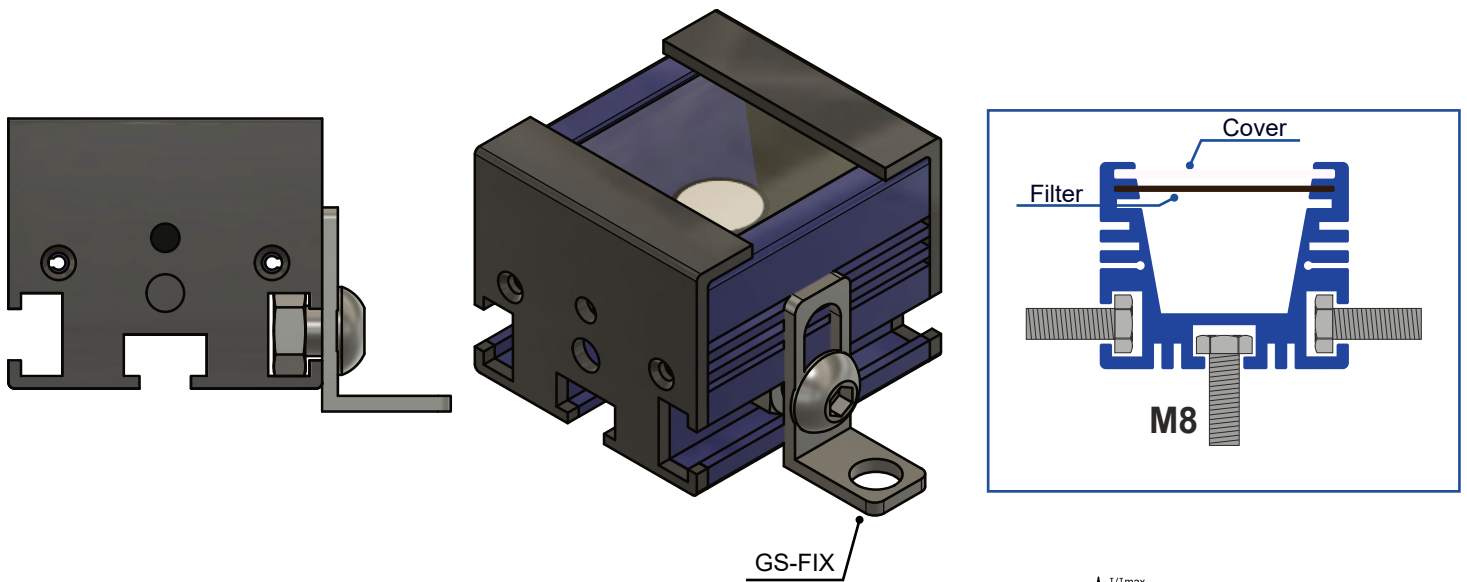

Tailor-Made

Connector	PINS	Function	Description
M12 Male	1		
	2		
	3		
	4		
	5		

DEVELOP YOUR CUSTOM PRODUCT WITH OUR R&D TEAM

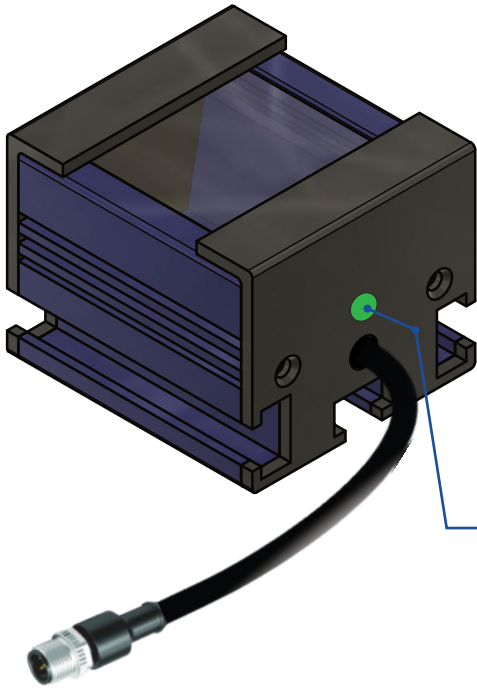

LED STATUS

Mode	Led colour signal	Function/note
Powered	Blue	-
100% Continuous use	Green	-
0-100% Analog Reg	Yellow	-
400% Strobe Use	Fast blinking green	-
200% Semi-continuous use standby	Purple	Without PNP or NPN input only +24V analog IN
200% Semi-continuous use	Slow blinking purple	With PNP o NPN input +24V analog IN
Over 10% ton error	Fast blinking red	10 sec stop
Over 80° temperature in pcb controller	Slow blinking green-yellow-red	Up to < 60° stop

The indicated IP protection degree is guaranteed only if the product is positioned downward

Base
IP54
Protection Degree

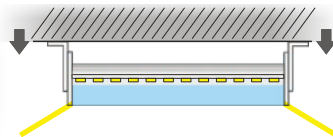

STANDARDS

EMC immunity :	EN 61547:2009	
EMC emission :	EN 55015:2013 + A1	
Photobiologic risk :	EN 62471:2008 GLS: RISK 1	Only for white light, continuous use
Assessment of lighting equipment related to human exposure to electromagnetic fields	EN 62493:2015	

WARNING

-Electrical device exclusively for professional use. Installation can be done by qualified personnel only.
-In case of power supply wire damage, its replacement has to be done at the head office exclusively.

Warranty loss in case of inappropriate use and tampering.



Design & Production
Made in Italy



Genesi LUX®

GENESI ELETTRONICA SRL - VIA BACHELET, 3/A - 41057 SPILAMBERTO (MO) - ITALY

info@genesi-lux.it - TEL. +39 059785566 - www.genesi-elettronica.com

©All Rights Reserved GENESI ELETTRONICA - GS - GENESI SPOT



Organization with a certified ISO 9001:2015 Quality Management System

Rev. 01/24