

# GEST300 MEGA-RING *Blue Line*

300 mm Convergent Lighting  
on the target

Internal  
Controller with  
**4 driving modes**

Internal controller with 4 driving modes	
1	100% Continuous use
2	200% Semi-continuous use
3	400% Strobe use
4	10-100% Analog Reg

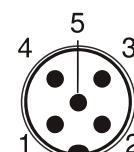
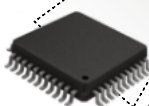

M12 5P Male Connector	
Pin 1	+24V
Pin 2	Start NPN < 1 to 0V
Pin 3	GND
Pin 4	Start PNP > 3 to 24V
Pin 5	1-10V Analog Reg.



Develop  
your custom  
solution

18  
Standard  
Colours

## Illuminator Features :

- Project achieved by internal resources and Genesi skills;
- Fast & modular controller which allows to have the following modes: PNP NPN, Analog Regulation, Strobe and Semi-Continuous Use;
- Microcontroller to monitor the pulse duration and the maximum temperature;
- Model with Huge Lenses; 10°, 30°, 60° or 90°;
- Powerful and Fast strobe mode with energy buffering and strobe duration control, Min. pulse from 3 µs;
- Convergent lighting on the target tailored according to your needs.



COLOUR	WHITE		UV-A				VISIBLE				NIR			SWIR				
	White 6000K -6K	White 4000K -4K	UV 365nm -365	UV 385nm -385	UV 395nm -395	UV 405nm -405	Blue 450nm -450	Green 524nm -524	Red 625nm -625	Deep Red 660nm -660	IR 730nm -730	IR 850nm -850	IR 950nm -950	SWIR 1050nm -1050	SWIR 1200nm -1200	SWIR 1300nm -1300	SWIR 1450nm -1450	SWIR 1550nm -1550
Continuous use power	30W		20W				30W				25W	30W		20W				
Semi-continuous use power	60W		35W				60W				50W	60W		30W				
Strobe use power	150W		60W				150W				120W	150W		50W				



**Genesi LUX**

GENESI ELETTRONICA SRL - VIA BACHELET, 3/A - 41057 SPILAMBERTO (MO) - ITALY  
[info@genesi-lux.it](mailto:info@genesi-lux.it) - TEL. +39 059785566 - [www.genesi-elettronica.com](http://www.genesi-elettronica.com)  
 ©All Rights Reserved GENESI ELETTRONICA - GEST300 MEGA-RING



Organization with a certified ISO 9001:2015 Quality Management System

Rev. 03/24

# GEST300 Part Number

Ex. Code : **GEST300** - **YYY** - **WW1** - **WW2** - **WW3**

-YYY	Led Colour	EN 62471	
-6K	Base 6000K Cold White	White	RISK1
-4K	4000K Natural White		RISK2
-365	UV 365 nm	UV - A	RISK3
-385	UV 385 nm		
-395	UV 395 nm		
-405	UV 405 nm		
-450	450 nm Royal Blue		
-524	524 nm Green	Visible	RISK1
-625	625 nm Red		
-660	660 nm Deep Red		
-730	730 nm IR	Nir	RISK2
-850	850 nm IR		
-950	950 nm IR		
-1050	1050 nm SWIR	Swir	RISK2
-1200	1200 nm SWIR		
-1300	1300 nm SWIR		
-1450	1450 nm SWIR		
-1550	1550 nm SWIR		
-YYY	Colours on demand		

-WW1	Cover variants
-T	Base Trasparent cover (90°)
-L10	10° Lens + Transparent Cover
-L30	30° Lens + Transparent Cover
-L60	60° Lens + Transparent Cover
-45T	45° Lens + Transparent Cover <span style="background-color: #d8bfd8; padding: 2px;">only UV-A</span>

-WW2	Angle Inclination
-A10	10° inclination angle
-A25	25° inclination angle
-A50	50° inclination angle
-AX	Customizable inclination

-WW2	IP
	Base IP 65
IP 67	IP 67 casing 8 mm Transparent Plexiglass + gaskets + screws

-WW2	Cables
	20 cm cable + M12 5P M
-WW2	Supply connection on demand

## Part Number Examples:

**Attention! In order to define the correct code, it's necessarily to know the working distance and the diameter of the targer to be illuminated**

**GEST300-6K-L30-A50**  
6000 K white leds, transparent cover, 30° lens, 20 cm cable + M12 5 pole connector, IP65 protection.

**GEST300-625-45T-A10**  
625 nm red leds, transparent cover, 45° lens, 20 cm cable + M12 5 pole connector, IP65 protection degree.

**GEST300-1200-L10-A25**  
1200 nm leds, transparent cover, 10° lens, 20 cm cable + M12 5 pole connector, IP65 protection degree.

*Optional wavelenghts and lens available on request*

# OPERATING MODE

## 100% CONTINUOUS USE

Connector	PINS	Function	Description
	1	+24 V	A) START NPN → PIN2: 0 to 1 V; B) START PNP → PIN4: 3 to 24 V;  For the continuous use: it is possible to connect PIN4 directly to +24 V or PIN2 to GND.
	2	A) Start NPN: 0-1 V	
	3	GND	
	4	B) Start PNP: 3-24 V	
	5	-	

## 200% SEMI-CONTINUOUS USE

Connector	PINS	Function	Description
	1	+24 V	<b>Precondition:</b> PIN5: 24 V  A) START NPN → PIN2: 0 to 1 V; B) START PNP → PIN4: 3 to 24 V;  <b>In this mode → Ton<sub>max</sub> = 60 s - Dt<sub>max</sub> = 50%</b>  For the semi-continuous use: it is possible to connect PIN4 directly to +24 V or PIN2 to GND.  To use it in continuous mode with DT <sub>max</sub> from 51% to 100%: it is necessary to use the heat sink or forced ventilation.
	2	A) Start NPN: 0-1 V	
	3	GND	
	4	B) Start PNP: 3-24 V	
	5	+24 V	

## 400% STROBE USE



Connector	PINS	Function	Description
	1	+24 V	A) START NPN → PIN2: 0 to 1 V; B) START PNP → PIN4: 3 to 24 V;  <b>In this mode → Ton<sub>max</sub> = 10 ms - Dt<sub>max</sub> = 10%</b>  AUTO-SWITCH in continuous use.
	2	A) Start NPN: 0-1 V	
	3	GND	
	4	B) Start PNP: 3-24 V	
	5	-	

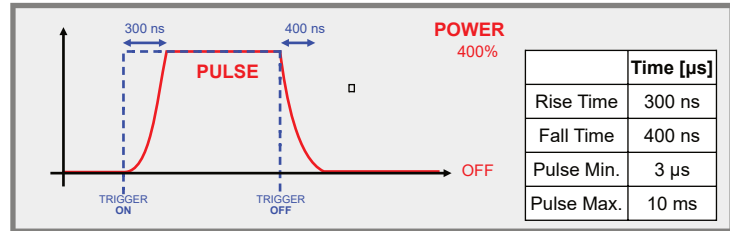
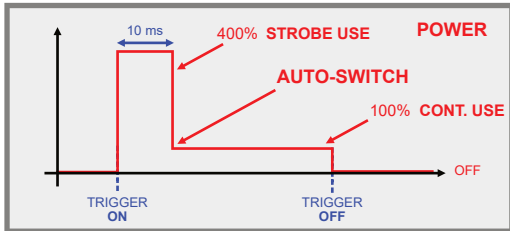

## ANALOG REGULATION USE 100%

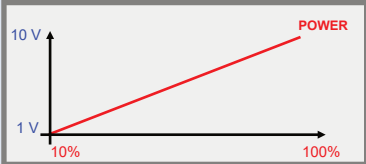
Connector	PINS	Function	Description
	1	+24 V	PIN5 from 1 to 10 V can adjust the power from 10% to 100%.  
	2	-	
	3	GND	
	4	-	
	5	1 V - 10 V	



400% STROBE USE POWER can be reached only from WHITE / VISIBLE / NIR LEDS, for other wavelengths check the power table at page 1.



MicroController temperature protection → at 80°C the PCB enables the protection and restores the functioning at T < 60°C.

# MECHANICAL DRAWING

Scale	Unit of measurement
1:4	mm
Weight	
2000 g	

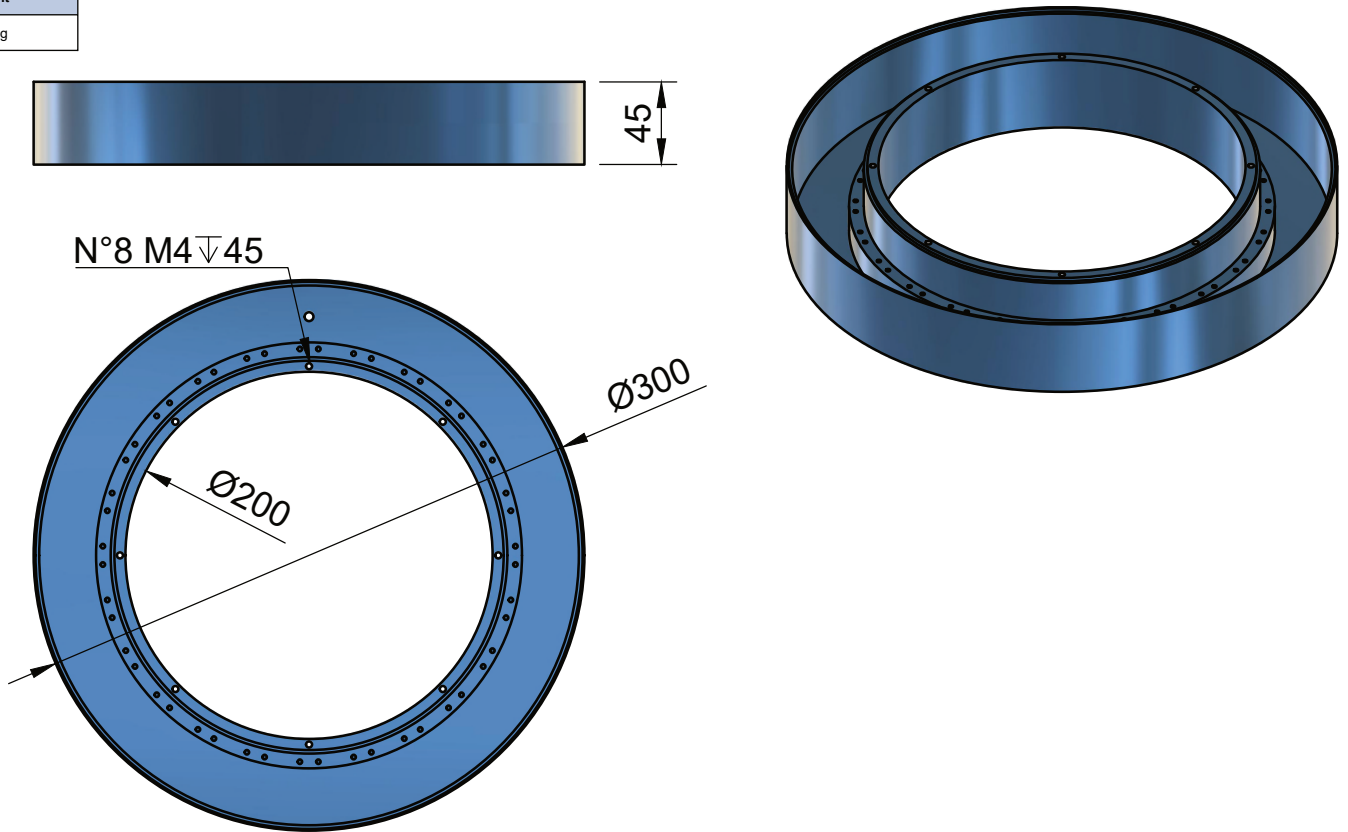

For 3D mechanical drawing requests - [info@genesi-lux.it](mailto:info@genesi-lux.it)

## LIGHT PROJECTION EXAMPLES

GEST300-625-L10-A25	
Led	Red 625 nm
Lens	10°
Angle	25°
Distance	30 cm
Diameter	10 cm

GEST300-6K-L10-A10	
Led	White 6K
Lens	30°
Angle	25°
Distance	30 cm
Diameter	15 cm

GEST300-470-L10-A50	
Led	Blue 470 nm
Lens	10°
Angle	50°
Distance	10 cm
Diameter	5 cm

GEST300-850-L10-A10	
Led	IR 850 nm
Lens	10°
Angle	10°
Distance	100 cm
Diameter	20 cm

# ACCESSORIES

CODE	DESCRIPTION
GEST300-PX2-AP	Additional Protection 2 mm Transparent Plexiglass + screws
GEST300-PX2-UV-AP	Additional Protection 2 mm <b>UV</b> permeable Transparent Plexiglass + screws
GEST300-ST2-AP	Additional Protection 2 mm Satin Plexiglass + screws
GEST300-OP2-AP	Additional Protection 2 mm Opaline Plexiglass + screws
GEST300-PC2-AP	Additional Protection 2 mm Transparent Polycarbonate + screws
GEST300-P-AP	Additional Protection 2 mm Transparent Plexiglass + <b>Polarizing Filter</b> + screws
GEST300-PX2-APF	Additional FULL Protection for Camera and illuminator 2 mm Transparent Plexiglass + screws
GEST300-PX8-AP	<b>IP 67</b> Additional Protection 8 mm Transparent Plexiglass + gaskets + screws
GE-M12F-5X050-2M	M12 connector female cable 2 meters long
GE-M12F-5X050-5M	M12 connector female cable 5 meters long
GE-M12F-5X050-10M	M12 connector female cable 10 meters long
GE-ABS606E	LED Voltage Control with 6 programmable channels and 10/100 Ethernet. Second level controller for Camera and illuminator.

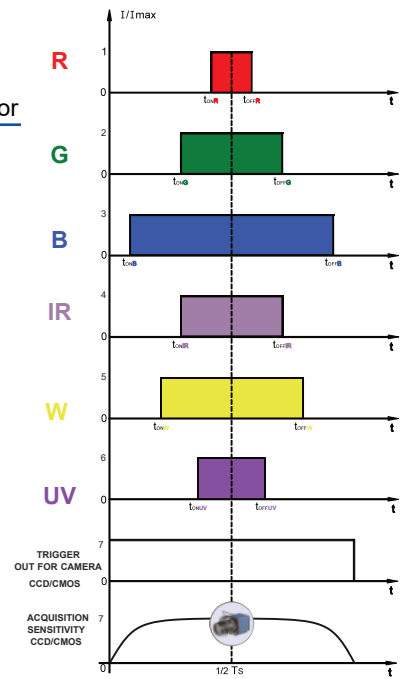
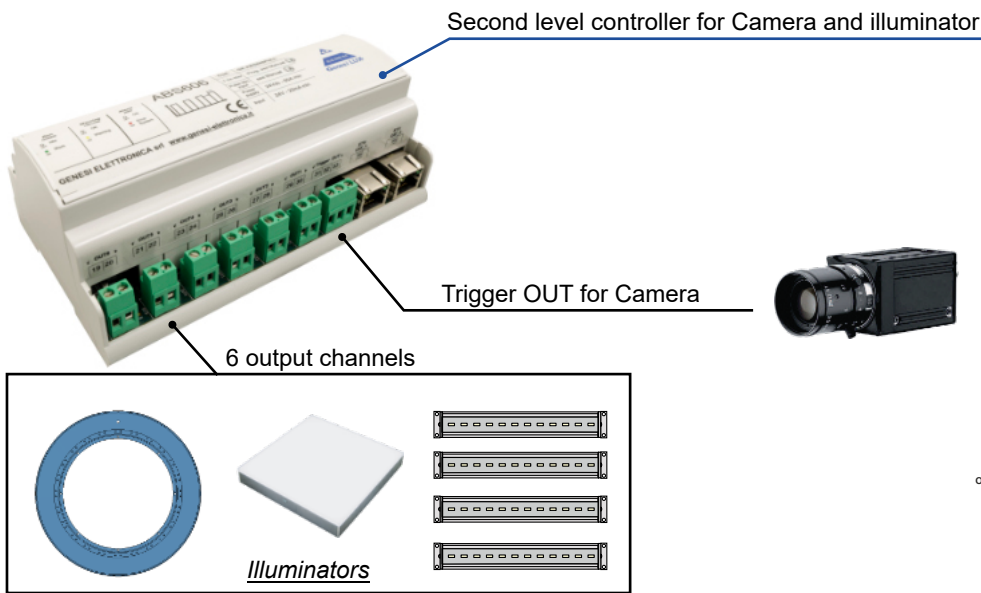
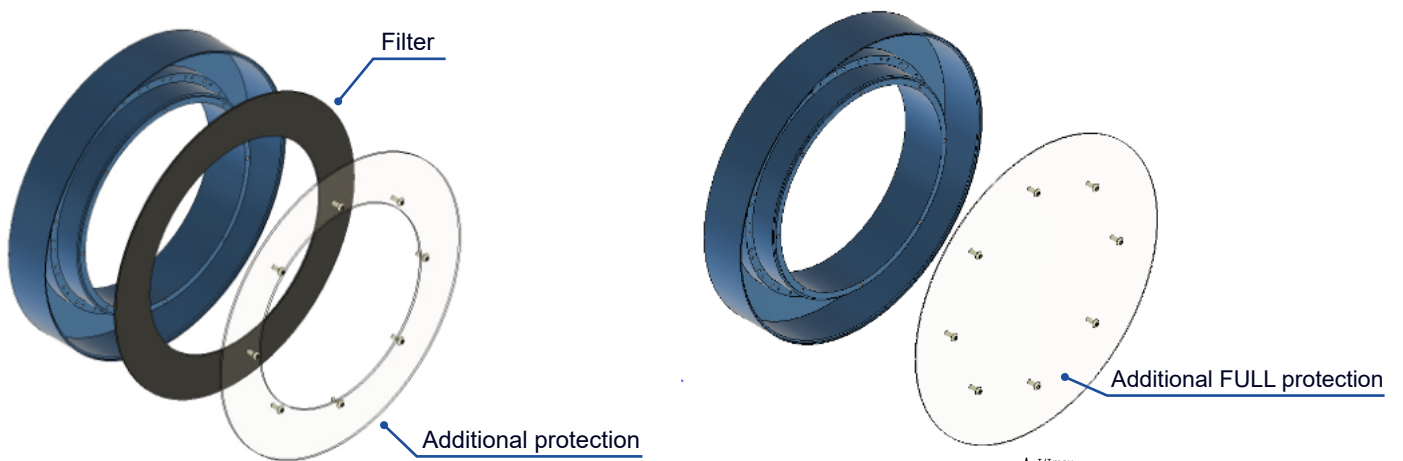

Design & Production  
Made in Italy



**Genesi LUX**

GENESI ELETTRONICA SRL - VIA BACHELET, 3/A - 41057 SPILAMBERTO (MO) - ITALY

[info@genesi-lux.it](mailto:info@genesi-lux.it) - TEL. +39 059785566 - [www.genesi-elettronica.com](http://www.genesi-elettronica.com)

©All Rights Reserved GENESI ELETTRONICA - GEST300 MEGA-RING



Organization with a  
certified ISO 9001:2015  
Quality Management System

Rev. 03/24

# SPECIAL VERSION

PHOTOMETRIC STEREO

CODE: GEST300-YYY-WW1-WW2-PHS

Connector	PINS	Function	Description
	1	OUT error (+24 V)	Illuminator with 4 sectors that can be driven independently. 100% continuous use, 200% semi continuous use, or 400% strobe for every sector.
	2	+24 V	
	3	A) Start PNP: 15-24 V	
	4	B) Start PNP: 15-24 V	
	5	C) Start PNP: 15-24 V	
	6	D) Start PNP: 15-24 V	
	7	GND	
	8	Set +24 V to semi continuous mode (200%)	

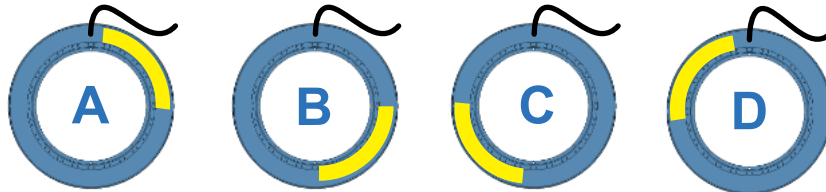

Tailor-Made

Connector	PINS	Function	Description
M12 Male	1		
	2		
	3		
	4		
	5		

**DEVELOP YOUR CUSTOM PRODUCT WITH OUR R&D TEAM**



**NEW SOLUTION**

DESIGN A NEW ONE

[info@genesi-lux.it](mailto:info@genesi-lux.it)



**SAMPLE**

TEST THE PRODUCT

[info@genesi-lux.it](mailto:info@genesi-lux.it)



**DOWNLOAD**

TECHNICAL SPECIFICATIONS





[www.genesi-elettronica.com](http://www.genesi-elettronica.com)



**REQUEST**

THE PRICE LIST

[info@genesi-lux.it](mailto:info@genesi-lux.it)

LED WARNING → Meaning:	
	Steady green LED Powered board
	Flashing green LED Powered board with driven LEDs
	Steady red LED Error report due to wrong pulse
	Flashing red LED Error report due to temperature

The indicated IP protection degree is guaranteed only if the product is positioned downward

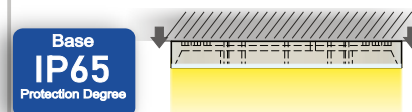

**STANDARDS**

EMC immunity :	EN 61547:2009
EMC emission :	EN 55015:2013 + A1
Photobiologic risk :	EN 62471:2008 GLS:
Assessment of lighting equipment related to human exposure to electromagnetic fields	EN 62493:2015

**WARNING**

-Electrical device exclusively for professional use. Installation can be done by qualified personnel only.

-In case of power supply wire damage, its replacement has to be done at the head office exclusively.

Warranty loss in case of inappropriate use and tampering.



**Genesi LUX®**

GENESI ELETTRONICA SRL - VIA BACHELET, 3/A - 41057 SPILAMBERTO (MO) - ITALY

[info@genesi-lux.it](mailto:info@genesi-lux.it) - TEL. +39 059785566 - [www.genesi-elettronica.com](http://www.genesi-elettronica.com)

©All Rights Reserved GENESI ELETTRONICA - GEST300 MEGA-RING



Organization with a certified ISO 9001:2015 Quality Management System

Rev. 03/24