

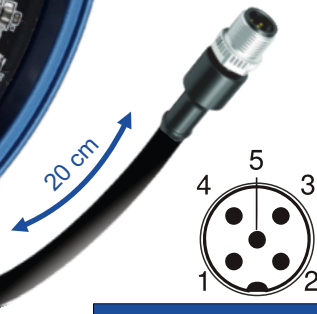

GEST130
MEGA-RING
Blue Line
 130 mm Direct light illuminator

Internal Controller with
4 driving modes



Internal controller with 4 driving modes	
1	100% Continuous use
2	200% Semi-continuous use
3	400% Strobe use
4	10-100% Analog Reg

M12 5P Male Connector	
Pin 1	+24V
Pin 2	Start NPN < 1 to 0V
Pin 3	GND
Pin 4	Start PNP > 3 to 24V
Pin 5	1-10V Analog Reg.

Develop your custom solution

18 Standard Colours

Base IP65 Protection Degree

24 Vdc

Optional Polarizing Filter

CE RoHS

UK CA

Illuminator Features :

- Project achieved by internal resources and Genesi skills;
- Fast controller which allows to have the following modes: PNP, NPN, Analog Regulation, Strobe and Semi-Continuous Use;
- Microcontroller to monitor the pulse duration and the maximum temperature;
- Model with Huge Lenses; 10°, 30°, 60° or 90° transparent, satin and opaline covers;
- Powerful and Fast strobe mode with energy buffering and strobe duration control, Min. pulse from 3 µs;

COLOUR	WHITE		UV-A				VISIBLE				NIR			SWIR				
	White 6000K -6K	White 4000K -4K	UV 365nm -365	UV 385nm -385	UV 395nm -395	UV 405nm -405	Blue 450nm -450	Green 524nm -524	Red 625nm -625	Deep Red 660nm -660	IR 730nm -730	IR 850nm -850	IR 950nm -950	SWIR 1050nm -1050	SWIR 1200nm -1200	SWIR 1300nm -1300	SWIR 1450nm -1450	SWIR 1550nm -1550
Continuous use power	15W		10W				15W				12W	15W		10W				
Semi-continuous use power	30W		18W				30W				25W	30W		15W				
Strobe use power	75W		30W				75W				60W	75W		25W				

GEST130 Part Number

Ex. Code : **GEST130** -YYY -WW1 -WW2 -WW3

-YYY	Led Colour	EN 62471	
-6K	Base 6000K Cold White	White	RISK1
-4K	4000K Natural White		RISK2
-365	UV 365 nm	UV - A	RISK3
-385	UV 385 nm		
-395	UV 395 nm		
-405	UV 405 nm		
-450	450 nm Royal Blue		
-524	524 nm Green	Visible	RISK1
-625	625 nm Red		
-660	660 nm Deep Red		
-730	730 nm IR	Nir	RISK2
-850	850 nm IR		
-950	950 nm IR		
-1050	1050 nm SWIR	Swir	RISK2
-1200	1200 nm SWIR		
-1300	1300 nm SWIR		
-1450	1450 nm SWIR		
-1550	1550 nm SWIR		
-YYY	Colours on demand		

-WW1	Cover variants
-T	Base Trasparent cover (90°)
-L10	10° Lens + Transparent Cover
-L30	30° Lens + Transparent Cover
-L60	60° Lens + Transparent Cover
-45T	45° Lens + Transparent Cover

-WW2	IP
	Base IP 65
IP 67	IP 67 casing 8 mm Transparent Plexiglass + gaskets + screws

-WW3	Cables
	20 cm cable + M12 5P M
-WW2	Supply connection on demand

Optional wavelenghts and lens available on request

Part Number Examples:

GEST130-6K-L30

6000 K white leds, transparent cover, 30° lens, 20 cm cable + M12 5 pole connector, IP65 protection degree.

GEST130-625-OP

625 nm red leds, opaline cover, 20 cm cable + M12 5 pole connector, IP65 protection degree.

GEST130-365-45T

365 nm UV leds, transparent cover, 45° lens, 20 cm cable + M12 5 pole connector, IP65 protection degree.

Design & Production
Made in Italy



Genesi LUX

GENESI ELETTRONICA SRL - VIA BACHELET, 3/A - 41057 SPILAMBERTO (MO) - ITALY

info@genesi-lux.it - TEL. +39 059785566 - www.genesi-elettronica.com

©All Rights Reserved GENESI ELETTRONICA - GEST130 MEGA-RING



Organization with a
certified ISO 9001:2015
Quality Management System

Rev. 03/24

OPERATING MODE

100% CONTINUOUS USE

Connector	PINS	Function	Description
	1	+24 V	A) START NPN → PIN2: 0 to 1 V; B) START PNP → PIN4: 3 to 24 V; For the continuous use: it is possible to connect PIN4 directly to +24 V or PIN2 to GND
	2	A) Start NPN: 0-1 V	
	3	GND	
	4	B) Start PNP: 3-24 V	
	5	-	

200 % SEMI-CONTINUOUS USE

Connector	PINS	Function	Description
	1	+24 V	Precondition: PIN5: 24 V A) START NPN → PIN2: 0 to 1 V; B) START PNP → PIN4: 3 to 24 V; In this mode → Ton_{max} = 60 s - Dt_{max} = 50% For the semi-continuous use: it is possible to connect PIN4 directly to +24 V or PIN2 to GND. To use it in continuous mode with DT _{max} from 51% to 100%: it is necessary to use the heat sink or forced ventilation.
	2	A) Start NPN: 0-1 V	
	3	GND	
	4	B) Start PNP: 3-24 V	
	5	+24 V	

400% STROBE USE



Connector	PINS	Function	Description
	1	+24 V	A) START NPN → PIN2: 0 to 1 V; B) START PNP → PIN4: 3 to 24 V; In this mode → Ton_{max} = 10 ms - Dt_{max} = 10% AUTO-SWITCH in continuous use.
	2	A) Start NPN: 0-1 V	
	3	GND	
	4	B) Start PNP: 3-24 V	
	5	-	

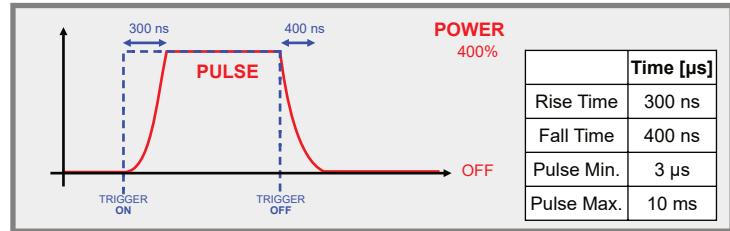
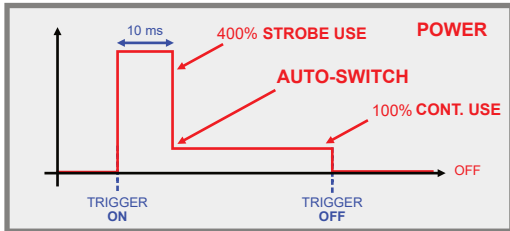

ANALOG REGULATION USE 100%

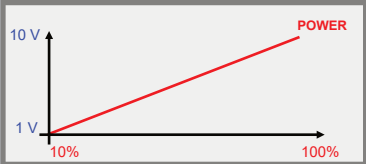
Connector	PINS	Function	Description
	1	+24 V	PIN5 from 1 to 10 V can adjust the power from 10% to 100%. 
	2	-	
	3	GND	
	4	-	
	5	1 V - 10 V	



400% STROBE USE POWER can be reached only from WHITE / VISIBLE / NIR LEDS, for other wavelengths check the power table at page 1.



MicroController temperature protection → at 80°C the PCB enables the protection and restores the functioning at T < 60°C.

MECHANICAL DRAWING

Scale	Unit of measurement
1:3	mm
Weight	
440 g	

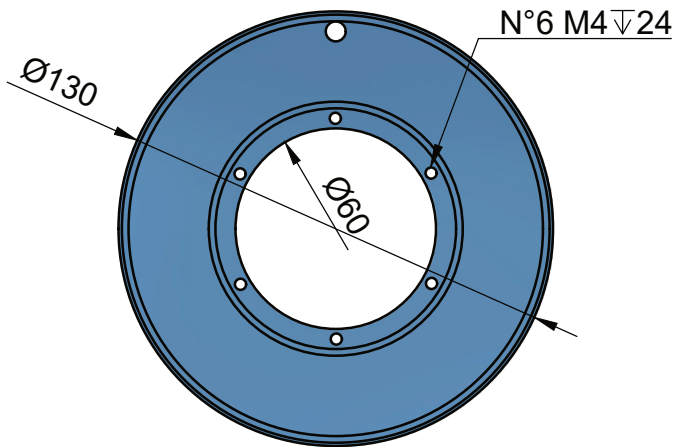
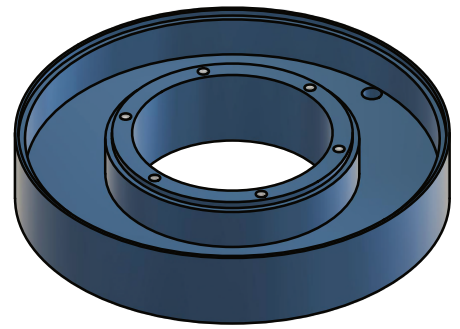

For 3D mechanical drawing requests - info@genesi-lux.it

LIGHT PROJECTION

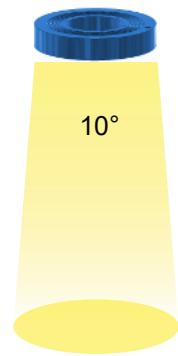
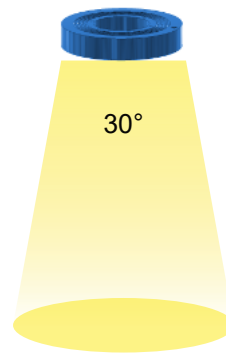
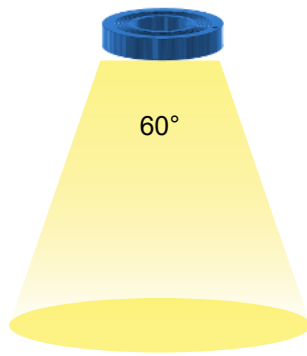
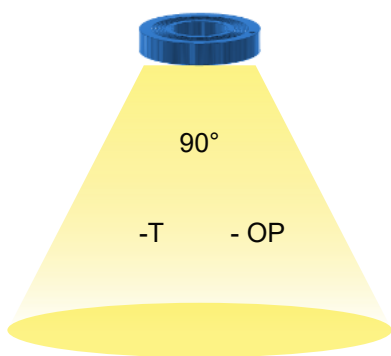

-T		
Working distance	Power W/m ²	Uniform area diameter
8 cm	68 - 126 - 270	18 cm
20 cm	31 - 58 - 124	20 cm
50 cm	8 - 14 - 30	35 cm

-L60		
Working distance	Power W/m ²	Uniform area diameter
15 cm	80 - 149 - 320	20 cm
50 cm	28 - 51 - 110	26 cm
100 cm	8 - 14 - 32	56 cm

-L30		
Working distance	Power W/m ²	Uniform area diameter
30 cm	75 - 140 - 300	18 cm
50 cm	50 - 95 - 200	22 cm
100 cm	20 - 36 - 80	28 cm

-L10		
Working distance	Power W/m ²	Uniform area diameter
40 cm	77 - 145 - 308	20 cm
100 cm	32 - 59 - 126	24 cm
200 cm	9 - 17 - 36	32 cm

-OP		
Working distance	Power W/m ²	Uniform area diameter
8 cm	31 - 58 - 124	18 cm
20 cm	13 - 24 - 50	22 cm
50 cm	3 - 6 - 12	35 cm

CONTINUOUS USE SEMI-CONTINUOUS USE STROBE USE

Powers related to the white colour with homogeneity ± 10%

Design & Production
Made in Italy



Genesi LUX

GENESI ELETTRONICA SRL - VIA BACHELET, 3/A - 41057 SPILAMBERTO (MO) - ITALY

info@genesi-lux.it - TEL. +39 059785566 - www.genesi-elettronica.com

©All Rights Reserved GENESI ELETTRONICA - GEST130 MEGA-RING



Organization with a certified ISO 9001:2015 Quality Management System

Rev. 03/24

ACCESSORIES

CODE	DESCRIPTION
GEST130-PX2-AP	Additional Protection 2 mm Transparent Plexiglass + screws
GEST130-PX2-UV-AP	Additional Protection 2 mm UV permeable Transparent Plexiglass + screws
GEST130-ST2-AP	Additional Protection 2 mm Satin Plexiglass + screws
GEST130-OP2-AP	Additional Protection 2 mm Opaline Plexiglass + screws
GEST130-PC2-AP	Additional Protection 2 mm Transparent Polycarbonate + screws
GEST130-P-AP	Additional Protection 2 mm Transparent Plexiglass + Polarizing Filter + screws
GEST130-PX2-APF	Additional FULL Protection for Camera and illuminator 2 mm Transparent Plexiglass + screws
GEST130-PX8-AP	IP 67 casing 8 mm Transparent Plexiglass + gaskets + screws
GE-M12F-5X050-2M	M12 connector female cable 2 meters long
GE-M12F-5X050-5M	M12 connector female cable 5 meters long
GE-M12F-5X050-10M	M12 connector female cable 10 meters long
GE-ABS606E	LED Voltage Control with 6 programmable channels and 10/100 Ethernet. Second level controller for Camera and illuminator.

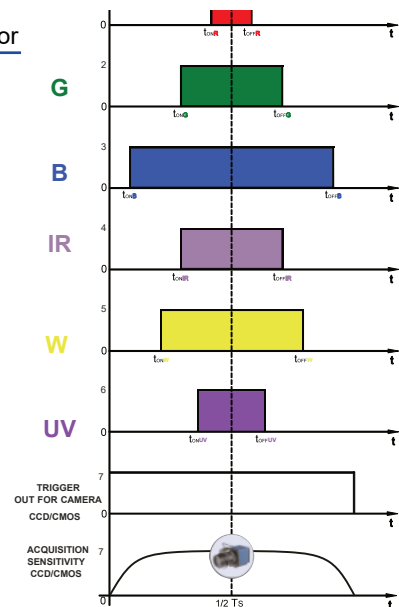
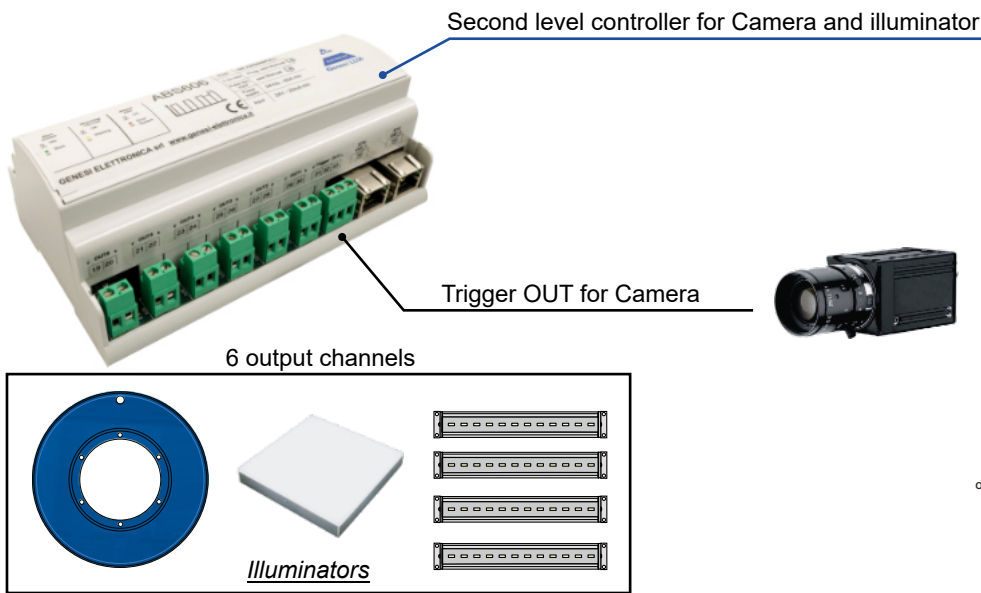
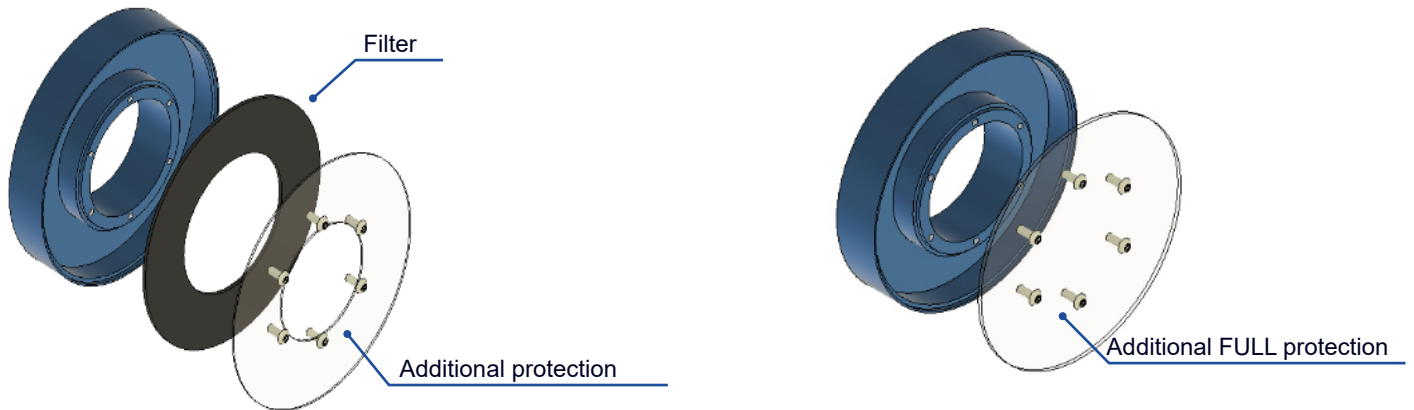

SPECIAL VERSION

PHOTOMETRIC STEREO

CODE: GEST130-YYY-WW1-PHS

Connector	PINS	Function	Description
	1	OUT error (+24 V)	Illuminator with 2 sectors that can be driven independently. 100% continuous use, 200% semi continuous use, or 400% strobe for every sector.
	2	+24 V	
	3	A) Start PNP: 15-24 V	
	4	B) Start PNP: 15-24 V	
	5	NC	
	6	NC	
	7	GND	
	8	Set +24 V to semi continuous mode (200%)	







Tailor-Made

Connector	PINS	Function	Description
M12 Male	1		
	2		
	3		
	4		
	5		

DEVELOP YOUR CUSTOM PRODUCT WITH OUR R&D TEAM

LED WARNING → Meaning:

 Steady green LED	Powered board
 Flashing green LED	Powered board with driven LEDs
 Steady red LED	Error report due to wrong pulse
 Flashing red LED	Error report due to temperature

The indicated IP protection degree is guaranteed only if the product is positioned downward

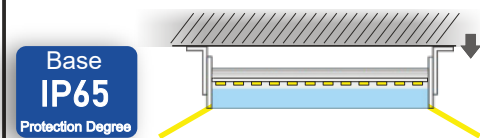

NEW SOLUTION

DESIGN A NEW ONE

info@genesi-lux.it



SAMPLE

TEST THE PRODUCT

info@genesi-lux.it



DOWNLOAD

TECHNICAL SPECIFICATIONS

www.genesi-elettronica.com



REQUEST

THE PRICE LIST

info@genesi-lux.it

STANDARDS

EMC immunity :	EN 61547:2009	
EMC emission :	EN 55015:2013 + A1	
Photobiologic risk :	EN 62471:2008 GLS:	
Assessment of lighting equipment related to human exposure to electromagnetic fields	EN 62493:2015	

WARNING

-Electrical device exclusively for professional use. Installation can be done by qualified personnel only.
 -In case of power supply wire damage, its replacement has to be done at the head office exclusively.

Warranty loss in case of inappropriate use and tampering.



Design & Production
Made in Italy



Genesi LUX®

GENESI ELETTRONICA SRL - VIA BACHELET, 3/A - 41057 SPILAMBERTO (MO) - ITALY

info@genesi-lux.it - TEL. +39 059785566 - www.genesi-elettronica.com

©All Rights Reserved GENESI ELETTRONICA - GEST130 MEGA-RING



Organization with a certified ISO 9001:2015 Quality Management System

Rev. 03/24