

M12 5P Male Connector	
Pin 1	+24V
Pin 2	Start NPN < 1 to 0V
Pin 3	GND
Pin 4	Start PNP > 3 to 24V
Pin 5	1-10V Analog Reg.

LED STATUS

Led Status	Internal controller with 4 driving modes	
1	100%	Continuous use
2	200%	Semi-continuous use
3	400%	Strobe use
4	10-100%	Analog Reg

Develop your custom solution

18 Standard Colours

Base IP65 Protection Degree

24 Vdc

Optional Polarizing Filter

CE RoHS

UK CA

Illuminator Features :

- Project achieved by internal resources and Genesi skills;
- Fast controller which allows to have the following modes: PNP, NPN, Analog Regulation, Strobe and Semi-Continuous Use;
- Microcontroller to monitor the pulse duration and the maximum temperature;
- Model with huge Lenses; 10°, 30°, 60° or 90° transparent, satin and opaline covers;
- Powerful and Fast strobe mode with energy buffering and strobe duration control, Min. pulse from 3 µs;

COLOUR	WHITE		UV-A				VISIBLE				NIR			SWIR				
	White 6000K -6K	White 4000K -4K	UV 365nm -365	UV 385nm -385	UV 395nm -395	UV 405nm -405	Blue 450nm -450	Green 524nm -524	Red 625nm -625	Deep Red 660nm -660	IR 730nm -730	IR 850nm -850	IR 950nm -950	SWIR 1050nm -1050	SWIR 1200nm -1200	SWIR 1300nm -1300	SWIR 1450nm -1450	SWIR 1550nm -1550
Continuous use power	7,5 W		5 W				7,5 W				6 W	7,5 W		5 W				
Semi-continuous use power	15 W		9 W				15 W				12,5W	15 W		7,5 W				
Strobe use power	37,5 W		15 W				37,5 W				30W	37,5W		12,5 W				



Genesi LUX

GENESI ELETTRONICA SRL - VIA BACHELET, 3/A - 41057 SPILAMBERTO (MO) - ITALY

info@genesi-lux.it - TEL. +39 059785566 - www.genesi-elettronica.com

©All Rights Reserved GENESI ELETTRONICA - GEST99 MEGA-RING



Organization with a certified ISO 9001:2015 Quality Management System

Rev. 01/24

GEST99 Part Number

Ex. Code : **GEST99** -YYY -WW1 -WW2

-YYY	Led Colour	EN 62471	
-6K	Base 6000K Cold White	White	RISK1
-4K	4000K Natural White		RISK2
-365	UV 365 nm	UV - A	RISK3
-385	UV 385 nm		
-395	UV 395 nm		
-405	UV 405 nm		
-450	450 nm Royal Blue		
-524	524 nm Green	Visible	RISK1
-625	625 nm Red		
-660	660 nm Deep Red		
-730	730 nm IR	Nir	RISK2
-850	850 nm IR		
-950	950 nm IR		
-1050	1050 nm SWIR	Swir	RISK2
-1200	1200 nm SWIR		
-1300	1300 nm SWIR		
-1450	1450 nm SWIR		
-1550	1550 nm SWIR		
-YYY	Colours on demand		

-WW1	Cover variants
-T	Base Trasparent cover (90°)
-L10	10° Lens + Transparent Cover
-L30	30° Lens + Transparent Cover
-L60	60° Lens + Transparent Cover
-45T	45° Lens + Transparent Cover

-WW2	Cables
	20 cm cable + M12 5P M
-WW2	Supply connection on demand

Part Number Examples:

GEST99-6K-T

6000 K white leds, transparent cover
20 cm cable + M12 5 pole connector, IP65 protection degree.

GEST99-6K-L10

6000 K white leds, transparent cover, 10° lens
20 cm cable + M12 5 pole connector, IP65 protection degree.

GEST99-6K-L30

6000 K white leds, transparent cover, 30° lens
20 cm cable + M12 5 pole connector, IP65 protection

Optional wavelenghts and lens available on request

OPERATING MODE

100% CONTINUOUS USE

Connector	PINS	Function	Description
	1	+24 V	A) START NPN → PIN2: 0 to 1 V; B) START PNP → PIN4: 3 to 24 V; For the continuous use: it is possible to connect PIN4 directly to +24 V or PIN2 to GND
	2	A) Start NPN: 0-1 V	
	3	GND	
	4	B) Start PNP: 3-24 V	
	5	-	

200 % SEMI-CONTINUOUS USE

Connector	PINS	Function	Description
	1	+24 V	Precondition: PIN5: 24 V A) START NPN → PIN2: 0 to 1 V; B) START PNP → PIN4: 3 to 24 V; In this mode → Ton_{max} = 60 s - Dt_{max} = 50% For the semi-continuous use: it is possible to connect PIN4 directly to +24 V or PIN2 to GND. To use it in continuous mode with DT _{max} from 51% to 100%: it is necessary to use the heat sink or forced ventilation.
	2	A) Start NPN: 0-1 V	
	3	GND	
	4	B) Start PNP: 3-24 V	
	5	+24 V	

400% STROBE USE



Connector	PINS	Function	Description
	1	+24 V	A) START NPN → PIN2: 0 to 1 V; B) START PNP → PIN4: 3 to 24 V; In this mode → Ton_{max} = 10 ms - Dt_{max} = 10% AUTO-SWITCH in continuous use.
	2	A) Start NPN: 0-1 V	
	3	GND	
	4	B) Start PNP: 3-24 V	
	5	-	

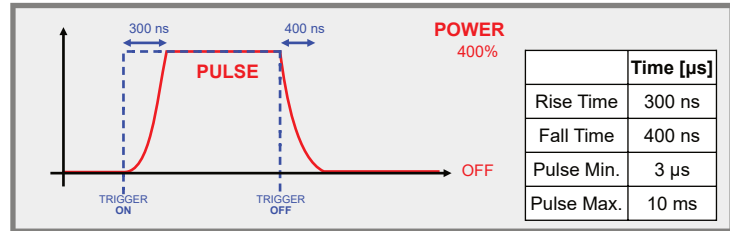
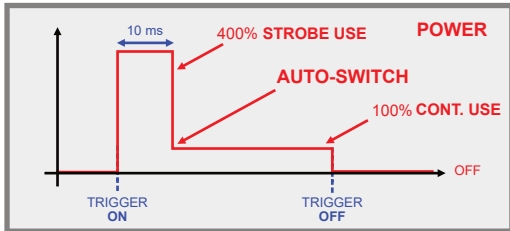

ANALOG REGULATION USE 100%

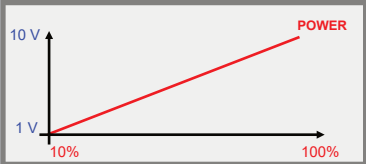
Connector	PINS	Function	Description
	1	+24 V	PIN5 from 1 to 10 V can adjust the power from 10% to 100%. 
	2	-	
	3	GND	
	4	-	
	5	1 V - 10 V	



400% STROBE USE POWER can be reached only from WHITE / VISIBLE / NIR LEDS, for other wavelengths check the power table at page 1.



MicroController temperature protection → at 80°C the PCB enables the protection and restores the functioning at T < 60°C.

MECHANICAL DRAWING

Scale	Unit of measurement
1:2	mm
Weight	
200 g	

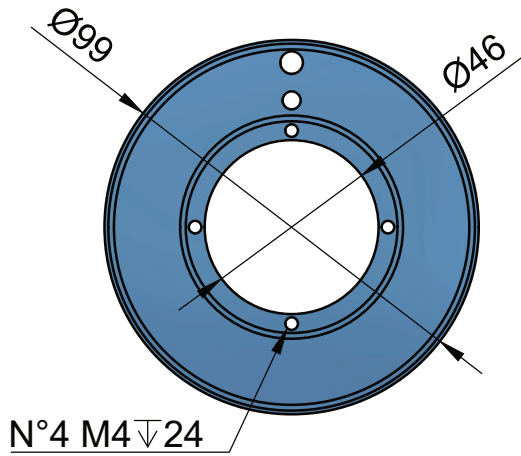
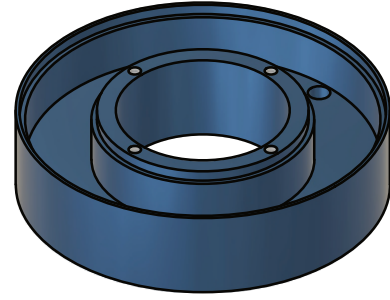

For 3D mechanical drawing requests - info@genesi-lux.it

LIGHT PROJECTION

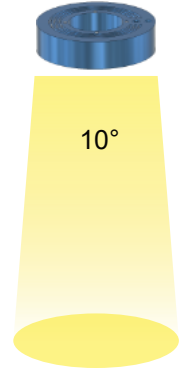
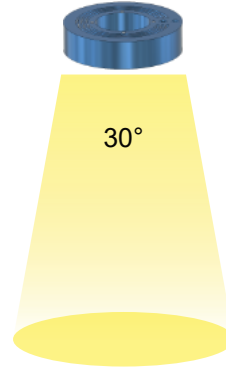
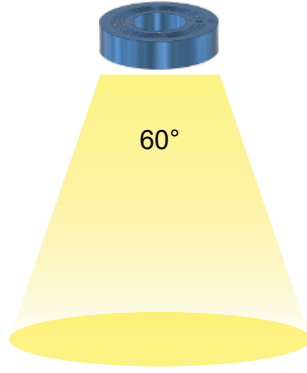
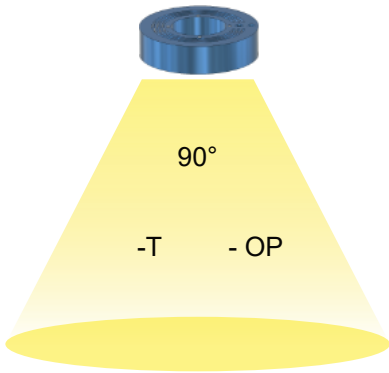

-T		
Working distance	Power W/m ²	Uniform area diameter
8 cm	TBD	TBD
20 cm	TBD	TBD
50 cm	TBD	TBD

-L60		
Working distance	Power W/m ²	Uniform area diameter
15 cm	TBD	TBD
50 cm	TBD	TBD
100 cm	TBD	TBD

-L30		
Working distance	Power W/m ²	Uniform area diameter
30 cm	TBD	TBD
50 cm	TBD	TBD
100 cm	TBD	TBD

-L10		
Working distance	Power W/m ²	Uniform area diameter
40 cm	TBD	TBD
100 cm	TBD	TBD
200 cm	TBD	TBD

-OP		
Working distance	Power W/m ²	Uniform area diameter
8 cm	TBD	TBD
20 cm	TBD	TBD
50 cm	TBD	TBD

CONTINUOUS USE SEMI-CONTINUOUS USE STROBE USE

Powers related to the white colour with homogeneity ± 10%

ACCESSORIES

CODE	DESCRIPTION
GEST99-PX2-AP	Additional Protection 2 mm Transparent Plexiglass + screws
GEST99-PX2-APF	Additional FULL Protection for Camera and illuminator 2 mm Transparent Plexiglass + screws
GEST99-PX2-UV-AP	Additional protection 2 mm transparent plexiglass UV permeable + screws
GEST99-ST2-AP	Additional protection 2 mm satin plexiglass + screws
GEST99-OP2-AP	Additional protection 2 mm opaline plexiglass + screws
GEST99-PC2-AP	Additional protection 2 mm opaline polycarbonate + screws
GEST99-P-AP	Additional protection 2 mm transparent plexiglass + Polarizing Filter + screws
GEST99-PX8-AP	Additional protection IP67 8 mm transparent plexiglass + gaskets + screws
GE-M12F-5X050-2M	M12 connector female cable 2 meters long
GE-M12F-5X050-5M	M12 connector female cable 5 meters long
GE-M12F-5X050-10M	M12 connector female cable 10 meters long
GE-ABS606E	LED Voltage Control with 6 programmable channels and 10/100 Ethernet. Second level controller for Camera and illuminator.

Filter

Additional protection

Additional FULL protection

Second level controller for Camera and illuminator

Trigger OUT for Camera

6 output channels

Illuminators

Timing Diagram:

- R: Red channel pulse (Low to High)
- G: Green channel pulse (Low to High)
- B: Blue channel pulse (Low to High)
- IR: Infrared channel pulse (Low to High)
- W: White channel pulse (Low to High)
- UV: UV channel pulse (Low to High)
- TRIGGER OUT FOR CAMERA: High pulse
- ACQUISITION SENSITIVITY: Pulse at $1/2 T_s$







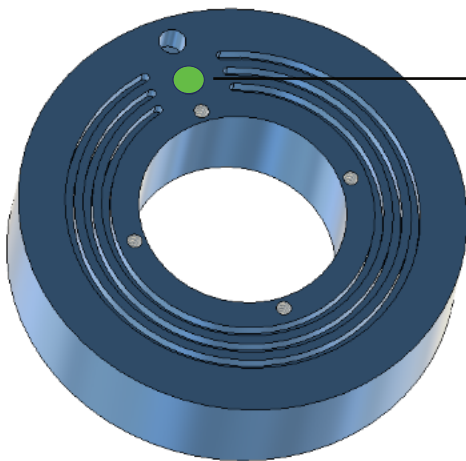

Tailor-Made

Connector	PINS	Function	Description
M12 Male	1		
	2		
	3		
	4		
	5		

DEVELOP YOUR CUSTOM PRODUCT WITH OUR R&D TEAM



LED STATUS

Mode	Led colour signal	Function/note
Powered	Blue 	-
100% Continuous use	Green 	-
0-100% Analog Reg	Yellow 	-
400% Strobe Use	Fast blinking green 	-
200% Semi-continuous use standby	Purple 	Without PNP or NPN input only +24V analog IN
200% Semi-continuous use	Slow blinking purple 	With PNP o NPN input +24V analog IN
Over 10% ton error	Fast blinking red 	10 sec stop
Over 80° temperature in pcb controller	Slow blinking green-yellow-red 	Up to < 60° stop

The indicated IP protection degree is guaranteed only if the product is positioned downward

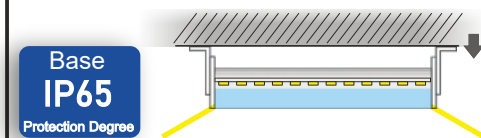

NEW SOLUTION

DESIGN A NEW ONE

info@genesi-lux.it



SAMPLE

TEST THE PRODUCT

info@genesi-lux.it



DOWNLOAD

TECHNICAL SPECIFICATIONS

www.genesi-elettronica.com



REQUEST

THE PRICE LIST

info@genesi-lux.it

STANDARDS

EMC immunity :	EN 61547:2009	
EMC emission :	EN 55015:2013 + A1	
Photobiologic risk :	EN 62471:2008 GLS:	
Assessment of lighting equipment related to human exposure to electromagnetic fields	EN 62493:2015	

WARNING

-Electrical device exclusively for professional use. Installation can be done by qualified personnel only.
-In case of power supply wire damage, its replacement has to be done at the head office exclusively.

Warranty loss in case of inappropriate use and tampering.



Design & Production
Made in Italy



Genesi LUX

GENESI ELETTRONICA SRL - VIA BACHELET, 3/A - 41057 SPILAMBERTO (MO) - ITALY

info@genesi-lux.it - TEL. +39 059785566 - www.genesi-elettronica.com

©All Rights Reserved GENESI ELETTRONICA - GEST99 MEGA-RING



Organization with a
certified ISO 9001:2015
Quality Management System

Rev. 01/24